

260W BEAM MOVE HEAD LIGHT[B]

# **USER MANUAL**

(TFT DISPLAY & TOUCH)

Please read over this manual before operation the light

# CONTENTS

Chapter 1 Installation and attention .....	1
1. Maintenance .....	1
2. Statement.....	1
3. Safety Precaution .....	1
4. Product Instruction.....	1
5. Cable connection (DMX) .....	2
6. Rigging (Optional).....	2
Chapter 2 Panel operation .....	4
1. Brief .....	4
2. Operation.....	4
1. Operate light with touch or encoder button.....	4
2. Parameter value setting .....	4
3. Boolean parameter setting.....	5
4. Sub Menu (Parameter) .....	5
3. Operation and parameter instruction .....	5
1. Set DMX Address .....	6
2. Set Light work mode .....	6
3. Set display.....	7
4. Test light.....	7
5. Set light run parameter .....	8
6. View status .....	8
Chapter 3 Channel description .....	9
1. Channel table.....	9

## Chapter 1 Installation and attention

### 1. Maintenance

- To reduce the risk of electrical shock or fire, do not expose this unit to rain or moisture.
- Intermittently using will extend this item's service life.
- Please clear the fan ,fan net , and optical lens in order to keep good work state.
- Do not use the alcohol or any other organic solvent to wipe the shell.

### 2. Statement

The product has perfect performance and integrity packing. All users should be strictly complying with the warning and operating instructions as stated. Or we aren't in charge of any result by misusing. Any damage resulting by misuse is not within the Company's warranty. Any fault or problem caused by neglecting the manual is also not in the charge of dealers.

**Note:** All information is subject to change without prior notice.

### 3. Safety Precaution

- In order to guarantee the product's life, please don't put it in the damp places or even the environment over 60degrees.
- Always mount this unit in safe and stable matter.
- Install or dismantle should operate by professional engineer.
- Using lamp, the change rate of power voltage should be within $\pm 10\%$ , If the voltage is too high, it will shorten the light's life; If it's not enough, will influence the effect.
- Please restart it 20 minutes later after turning off light , until full-cooling. Frequent switching will reduce the life span of lamps and bulbs; intermittent using will improve the life of bulbs and lamps.
- In order to make sure the product is used well, please read the Manual carefully.

### 4.

#### Product Instruction

- lamp: ROCCER MSD Platinum 10R (life:2000 hours Color temperature: 7800K)
- Channel mode:18 DMX512 Channel
- Pan scan: 540 (16bit) Electric correction
- Tilt scan: 270 °(16bit) Electric correction
- Amazing dot matix, four tact switch, 180 °turning show
- Color wheel: one color wheel, 14 kinds of color chips in one color wheel
- Gobo: 14 gobos
- Effect Wheel: Rotation eight prism, effect move , frost

- 0-100% mechanical dimming, mechanical dimming and free dimming available.
- strobe macro control available.
- Lens optical system achanical fouce .beam angle 0~4 °
- Over heat protection
- Power Input: 100-240V, 50/60Hz
- Power Dissipation: 550W
- IP level :IP20
- Magnetic ballast and AC/Dc power supply
- Product Size: 523×337×511mm
- Packing Size: 635X440X725
- Net weight: 25.5KG

## 5. Cable connection (DMX)

Use a cable conforming to specifications EIA RS-485: 2-pole twisted, shielded, 120Ohm characteristic impedance, 22-24 AWG, low capacity. Do not use microphone cable or other cable with characteristics differing from those specified. The end connections must be made using XLR type 3 or 5-pin male/female connectors. A terminating plug must be inserted into the last projector with a resistance of 120Ohm (minimum 1/4 W) between terminals 2 and 3.

**IMPORTANT:** The wires must not make contact with each other or with the metal casing of the connectors. The casing itself must be connected to the shield braid and to pin 1 of the connectors.

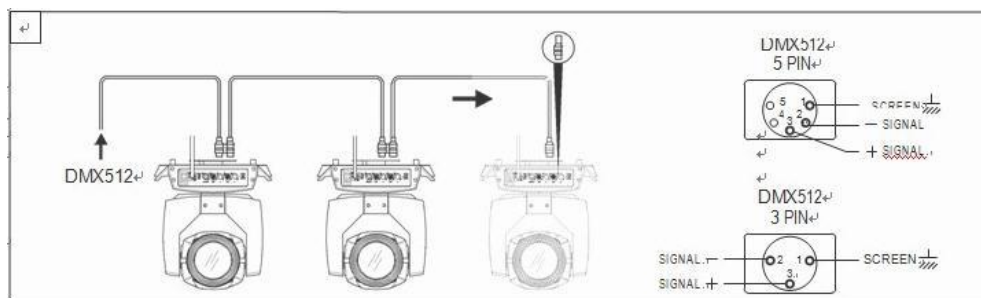

Figure 1 DMX Cable connection

## 6. Rigging (Optional)

This equipment can be positioned and fixed by clamp in every direction of the stage. Locking system makes it easy to fasten to the bracket.

Attention! Two clamps is needed to fix the equipment. Every clamp is locked by fastener of 1/4 kind. Fastener can only be locked clockwise.

Attention! Fasten a safety string to the additional hole of side aluminum piece. The secondary accessory can not hang on the delivery handle. Nip the equipment on bracket.

- Check if rigging clamp (not including the one inside) damaged or not? If stand ten times weight as the equipment. Make sure the architecture can stand ten times weight as all the equipments, clamps, wirings and other additional fixtures.
- Screws for clamping must be fixed firmly. Take one M12 screw (Grade 8.8 or higher) to clamp bracket, and then screw the nuts.
- Level the two hanging points at the bottom of clamp. Insert fastener to the bottom, lock the two levers by 1/4 rotating clockwise; then install another clamp.
- Install on safety string which stands at least ten times weight as equipment. Terminal of the accessory is designed for clamps.
- Make sure pan/tilt lock unlocked or not. Keep the distance more than 1M from equipment to flammable material or lighting source.

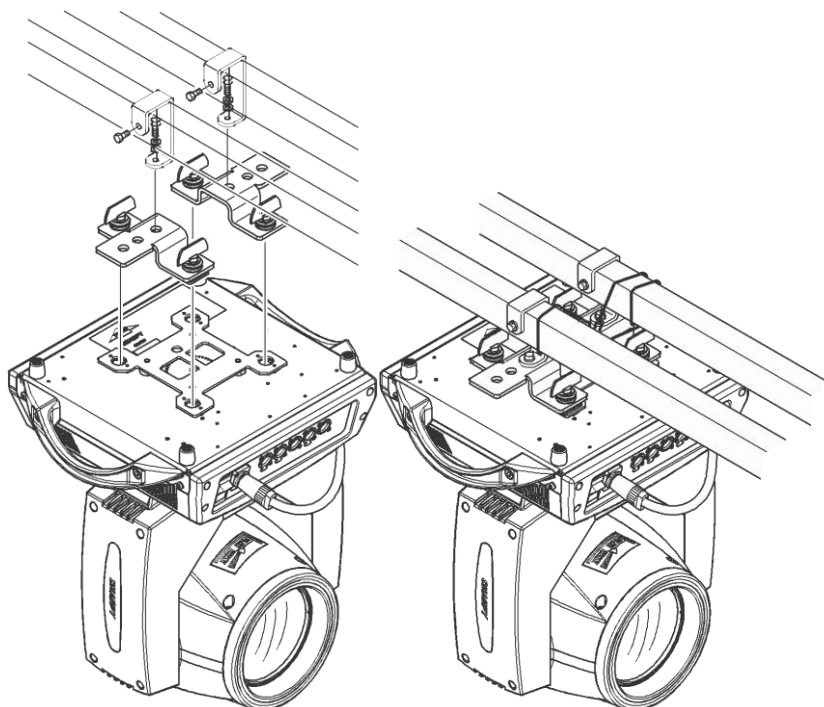

Figure 2 Installation

## Chapter 2 Panel operation

### 1. Brief

The light panel diagram show as Figure 3, Left area is TFT Displayer, support touch, and right area is encoder button, both of touch and coder button can operate light and setting.

Display & operation just like 'Android operation system', touch the item will set or modify setting.

Note: Prevent damage the touch or TFT displayer, Can not use sharp objects chick displayer.

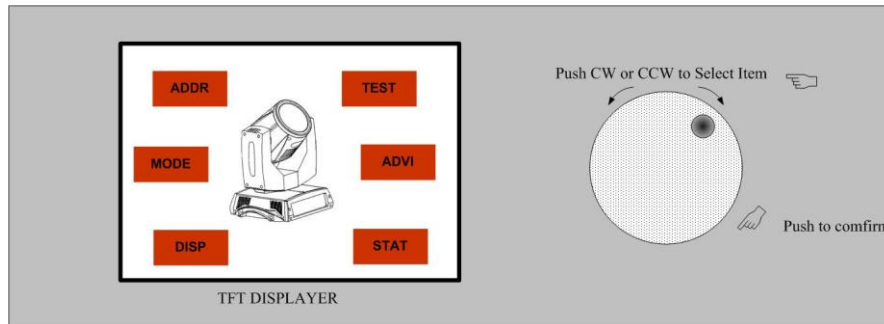

Figure 3 Panel diagram

### 2. Operation

#### 1. Operate light with touch or encoder button

- The left area is TFT Displayer and touch, chick item or value with finger will to complete operation of set light setting(parameters) or view light state.
- The area on the right hand side is rotary encoder with button, As auxiliary input interface, if disable touch function,, the encoder can been choose to set or view the item, and then press the encoder button to confirm the selection, rotary encoder again set the parameter value, finally, Press encoder button one again to save value or setting.

#### 2. Parameter value setting

When the selected item is value need to been modified, the dialog shown in Figure 4 will popup.

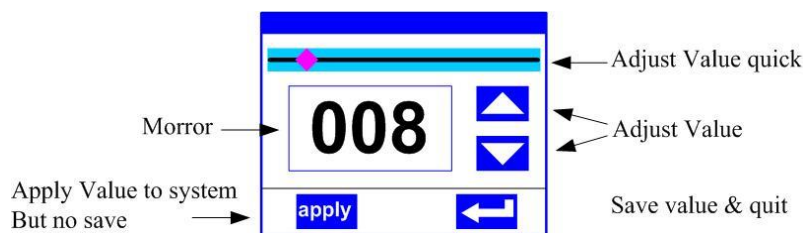

Figure 4 Dialog of value setting

- **Modify value:** Can quickly modify value via pull the slider to the desired position, or click the button of 'up' or 'down' whit finger on the right side to set the exact desired value, another way is roll encoder on the right hand side of panel.
- **Apply value:** When Value had been modified, Then press the bottom of 'apply' in the left corner to apply to the light, but hav't saved;
- **Save Value:** Any time, click on the lower right corner of the "OK" button, the setting will

been saved into internal memory.

### 3. Boolean parameter setting

- when the selected parameters is a Boolean value (such as ON or OFF), can directly modify setting by click corresponding item, the setting will be saved right now.
- When the parameter is a key item, click corresponding item, a dialog shown in Figure 5 will be popup ask for the confirm. Click 'sure' to confirm.

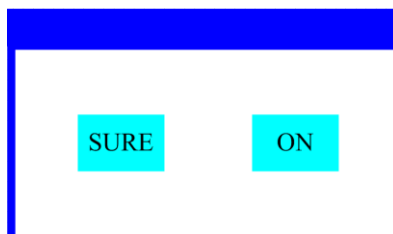

Figure 5 Dialog of confirm

### 4. Sub Menu (Parameter)

Click item of main menu, enter corresponding sub menu, shown in Figure 6, total 6 sub menu, includes class of parameter and status:

- ADDRESS: Set light DMX address.
- WORKMOD: Set light work mode, master or slave mode when in auto run mode.
- DISPLAY: Set display parameter, eg. select language.
- TEST: Used for test light, modify DMX channel data to test function, the corresponding function of reference channel function table.
- ADVANCE: Set light running parameter.
- STATUS: view light current status.



Figure 6 Parameter menu

### 3. Operation and parameter instruction

Via following operation, enter sub menu(parameter menu) shown in Figure 6

- In main menu, click 1/6 function button into corresponding parameter menu.
- In sub menu(page), click main item on the left side of display, can shift to corresponding sub menu(page) quickly.

## 1. Set DMX Address

Click and select the "ADDR", can enter the page of DMX address setting, range from 1 to 512, the address code shouldn't is not greater than (512- channels quantity), otherwise the light will not be controlled. Following is the operation:

Enter the page of DMX address, as shown in Figure 7, click the blank area in right side of display will pop-up diglog as in Fig. 4, modify value, then click 'ENTER' to confirm and save DMX address code.

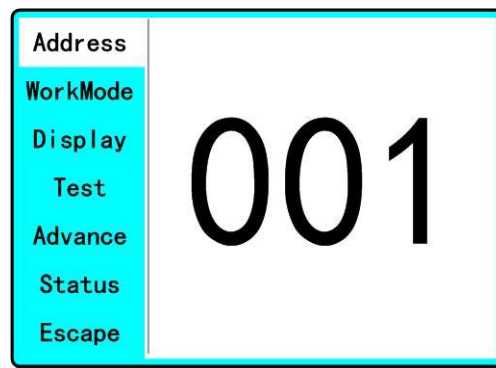

Figure 7 page of DMX Address

## 2. Set Light work mode

Enter the page of 'WORK MOD' as shown in Figure 8 and modify setting. Can set light work mode, control lamp and DMX channel mode..

Light includes 3 work mode: DMX MODE, AUTO RUN and SOUND MODE, Parameter definition as following:

- **DMX Mode:** Under this mode, the light receive data from the DMX controller and move.
- **AUTO RUN:** Under this mode, light will run with inside code(data), ignore data from DMX controller.
- **SOUND Ctrl:** Under this mode, light ignore data from DMX controller., When there is a strong sound in stage, the light will run a scene, otherwise it will keep the last scene.
- **M/S Choose:** 'M/S Choose' is available when light just in 'AUTO RUN' or 'SOUND Ctrl' mode. If this item is set as 'OFF', the light don't send data to other light via DMX Cable. When 'ON', the data will send to other slave light immediately.
- **Lamp control:** Turn on lamp when this item is set 'ON', otherwise, turn off lamp. The gap between operation is limited to 30 second.
- **Channel mode:** Light support 2 DMX Channel mode: sample or extend.

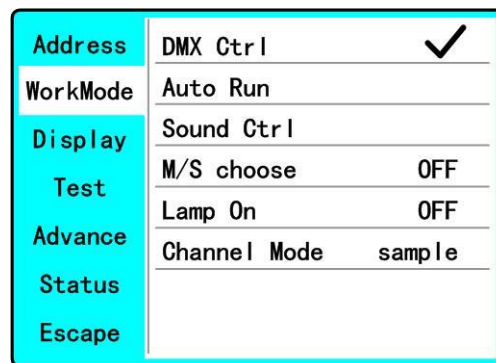

Figure 8 page of work mode



### 3. Set display

Light support 2 language, rotation display, Enter page as shown in Figure9 to set parameter following:

- **Language:** Select display as simplified Chinese or English.
- **Screen Saver:** when panel is idle(these is no operation in 10 second), displayer will enter saver status. When set as 'mode 1', saver status is close display, as 'mode 2' saver status will display DMX address code(DMX MODE) or display LOGO(AUTO RUN or SOUND CTRL). As 'OFF', keep light up displayer and show main menu.
- **Screen Rotation:** rotate displayer.
- **Touch enable:** Disable or enable touch function, when disable, use encoder to operate light and set parameter.
- **Touch adjust:** adjust touch function, normally, not enter this item.

Address	Langudge	中文
WorkMode	Screen saver	mode 1
Display	Screen rotation	OFF
Test	Touch Enable	ON
Advance	Touch adjust	
Status		
Escape		

Figure9 page of display

### 4. Test light

Enter the page as shown in Figure 10, Light will into test mode, in this mode, the light does not receive the data for DMX controller.:

- PAN: range for 0 to 255;
- TILT: range for 0 to 255;
- FOCUS: range for 0 to 255;
- COLOR: range for 0 to 255;
- GOBO: range for 0 to 255;
- PRISM: range for 0 to 255;
- FROST: range for 0 to 255;;
- STROBE: range for 0 to 255;.

Address	PAN	000
WorkMode	TILT	000
Display	FOCUS	000
Test	COLOR	000
Advance	GOBO	000
Status	PRISM	000
Escape	FROST	000
	STROBE	000

Figure 10 page of Test

### 5. Set light run parameter

Enter the page as shown in Figure 10, set the parameter of light:

- Pan Invert: Reverse PAN move.
- Tilt Invert: Reverse TILT mover.
- Rectify enable: set as 'OFF', PAN or TILT will disable position rectify function. As 'ON', when PAN or TILT lose steps, light will rectify auto.
- Pan Offset: Set PAN original position.
- Tilt Offset: Set TILT original position.
- Lamp up when: Select lamp on mode, includes 3 mode: power on, after reset done and manual;
- Factory setting: restore all parameter to factory setting.

Address	PAN Inset	OFF
WorkMode	TILT Inset	OFF
Display	Rectify Enable	ON
Test	PAN Offset	008
	TILT Offset	020
Advance	Lamp on when	pwr on
Status	Factory Setting	
Escape		

Figure 11 page of run parameter

### 6. View status

Enter the page as shown in Figure 12:

- View light current status, version;
- DMXClr: Click to clear all DMX data to '0'.
- SysRst: Click to reset light.

Address	Work Mode	DMX ...
WrokMode	Address	001
Display	Version	B5R.1.1 16n
Test	Elapse	000H 04M
	Tatol	00000H 04M
Advance		
Status	<input type="button" value="DMX Clr"/> <input type="button" value="SysRst"/>	
Escape		

Figure 12 page of status

## Chapter 3 Channel description

### 1. Channel table

Light support 2 DMX mode: 16ch (Sample) and 20ch (extend), as shown in Table 1:

Table 1 Channel brief

CHANNEL	NAME	VALUE	DEFIF
CH1	PAN	0-255	0-540°
CH2	PAN 16bit	0-255	
CH3	TILT	0-255	0-270°
CH4	TILT 16bit	0-255	
CH5	XY Speed	0-255	Fast to slow
CH6	Dimmer	0-255	0-100%
CH7	Strobe	0-3	Drak
		4-103	Slow strobe to fast strobe
		104-107	White
		108-207	Slow strobe to fast strobe(mode 2)
		208-212	White
		213-251	Free strobe
		252-255	White
CH8	Frost	0-127	None
		128-255	Insert frost
CH9	COLOR	0-4	White
		5-9	White + COLOR1
		10-14	COLOR1
		15-19	COLOR1 + COLOR2
		20-24	COLOR2
		25-29	COLOR2 + COLOR3
		30-34	COLOR3
		35-39	COLOR3 + COLOR4
		40-44	COLOR4
		45-49	COLOR4 + COLOR5
		50-54	COLOR5
		55-59	COLOR5 + COLOR6
		60-64	COLOR6
		65-69	COLOR6 + COLOR7
		70-74	COLOR7
		75-79	COLOR7 + COLOR8
		80-84	COLOR8
85-89	COLOR8 + COLOR9		
90-94	COLOR9		
95-99	COLOR9 + COLOR10		
100-104	COLOR10		

		105-109	COLOR10 + COLOR11
		110-114	COLOR11
		115-119	COLOR11 + COLOR12
		120-124	COLOR12
		125-129	COLOR12 + COLOR13
		130-134	COLOR13
		135-139	COLOR13 + COLOR14
		140-199	Rotate forward (fast to slow)
		200-255	Rotate reverse (slow to fast)
<b>CH10</b>	<b>GOBO</b>	0-4	White
		5-9	GOB01
		10-14	GOB02
		15-19	GOB03
		20-24	GOB04
		25-29	GOB05
		30-34	GOB06
		35-39	GOB07
		40-44	GOB08
		45-49	GOB09
		50-54	GOB010
		55-59	GOB011
		60-64	GOB012
		65-69	GOB013
		70-125	Rotate forward (fast to slow)
		126-130	Stop
		131-190	Rotate reverse (slow to fast)
		191-195	Shake slow to fast GOB01
		196-200	Shake slow to fast GOB02
		201-205	Shake slow to fast GOB03
		206-210	Shake slow to fast GOB04
		211-215	Shake slow to fast GOB05
		216-220	Shake slow to fast GOB06
		221-225	Shake slow to fast GOB07
		226-230	Shake slow to fast GOB08
231-235	Shake slow to fast GOB09		
236-240	Shake slow to fast GOB010		
241-245	Shake slow to fast GOB011		
246-250	Shake slow to fast GOB012		
251-255	Shake slow to fast GOB013		
<b>CH11</b>	<b>Colorful</b>	0-127	None
		128-255	Insert Colorful
<b>CH12</b>	<b>Prism</b>	0-30	None
		31-50	Prism1

		51-70	Prism2
		71-90	Prism3
		91-110	Prism4
		111-130	Prism5
		130-150	Prism6
		151-170	Prism7
		171-190	Prism8
		191-210	Prism9
		211-230	Prism10
		231-255	Prism11
CH13	Prism1 Rot	0-127	0-400 degrees
		128-187	Rotate forward (fast to slow)
		188-195	Stop
		196-255	Rotate reverse (slow to fast)
CH14	Prism2 Rot	0-127	0-400 degrees
		128-187	Rotate forward (fast to slow)
		188-195	Stop
		196-255	Rotate reverse (slow to fast)
CH15	Macro	0-30	None
		31-50	Macro1
		51-70	Macro2
		71-90	Macro3
		91-110	Macro4
		111-130	Macro5
		130-150	Macro6
		151-170	Macro7
		171-190	Macro8
		191-210	Macro9
		211-230	Macro10
231-255	Macro11		
CH16	Focus	0-255	From far to near
CH17	Lamp	100-105	Close lamp over 3 sencods
		200-205	Open lamp over 3 sencods
CH18	Reset	240-255	Reset over 3 sencods